



High quality-worldwide Sharing

Contact us

潘今晴 Pan

Tel: +139 1606 5040

E-mail: panjinqing@mzcn.shop

上海形美设计营销中心

上海闵行区中春路8633弄万科虹桥云24幢20号618

Room618, No.20, Building24, Vanke hongqiao cloud,
Lane 8633, zhongchun RD, Minhang district, Shanghai

广州营销中心——广州天河区长兴路5号B座308

No.308, Building B, ChangXing RD. TianHe distric. GuangZhou

安徽铭装制作基地——安徽宣城泾县城东开发区纬四路

Weisi RD. East Economic Development Area. Jing County. XuanCheng. AnHui

GXL Creative Inc.



Brochures for Products

www.mzcn.shop



MZ PACK

Innovation leads the Industry in the future

The professional and first-class quality

Brief Introduction

Our company has been a professional manufacturer and dealer of cosmetic containers for 12 years. With experienced product R&D team, we always commit ourselves to the self-development of the new products, at the same time offer the customers private-mode production service with charming personality.

The capacitance range of the bottle is from 5ml to 1000ml, while the diameter of bottle is from \varnothing 14mm to \varnothing 90mm to satisfy customers' requirements with various of capacities and specification. Production process from design, mold making to injection molding, blowing, through the manufacturing and printing, hot stamping (silver), painting, plating and other secondary processing operations, the contents of the characteristics of perfect reflected and safe keeping, and to improve the image of the product.

Our company specializes in the integration of packaging, and we have established good business relationships with many famous manufacturers of cosmetic containers all around the world. Thus, we can offer customers a complete range of products to reduce the risk of a number of procurement and the cost of the incomplete accessories.

Types of products:

Blowing bottles: HDPE, PET, PETG and PP, etc.

Injected bottled: PMMA (ACRYLIC), PETG, AS, PP and ABS, etc.

Various high-quality deep cleansing pumps, airless pumps, spraying pumps and lotion pumps, etc.

Others: PMMA, imported airless bottles, glass bottles, essential oil bottles, aluminum bottles, aluminum pots and accessories, etc.

Patent Product



Retain freshness cleaning water bottle



1

2



Product Drawing



rotating-screw
safty structure

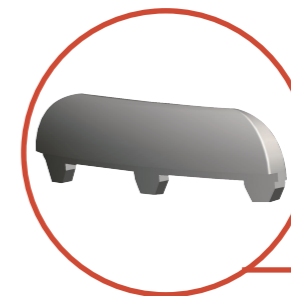

Bayonet retain
freshness
structure



1 2
3 4

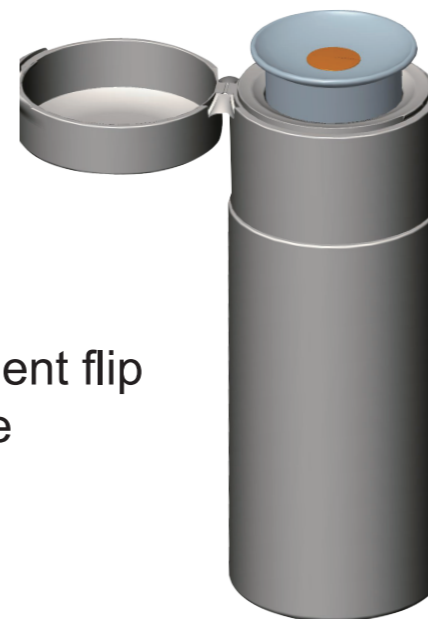

Convenient flip
structure

Convenient Hygiene
Backflow prevention



Patent Product



Emulsion bottle

Product Drawing

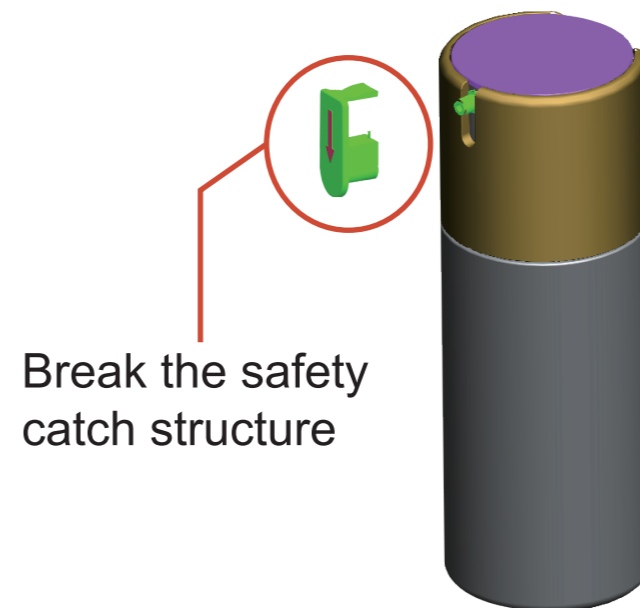
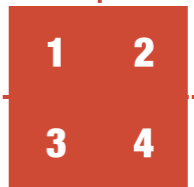
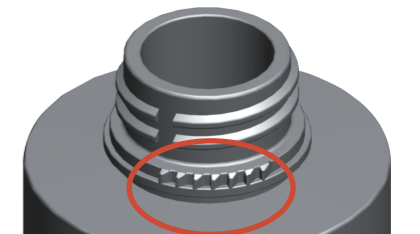
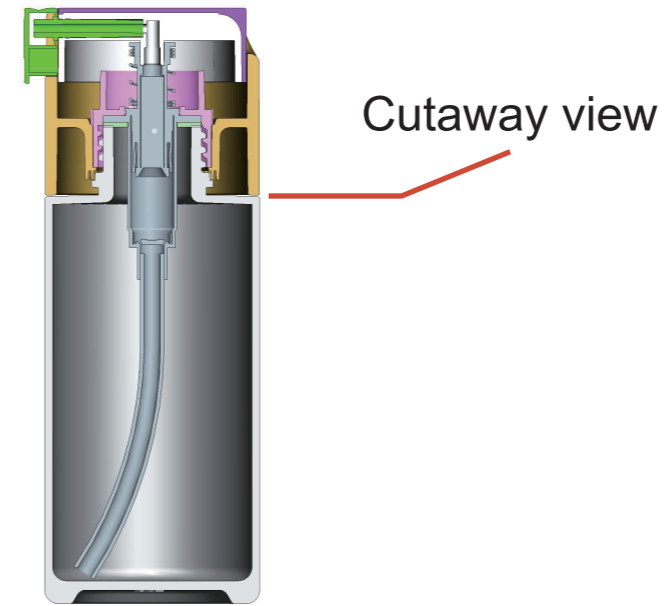

Convenient Hygiene
Backflow prevention

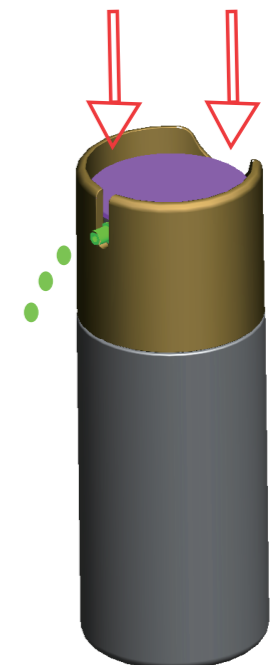

Patent Product



Cream bottle



Product Drawing

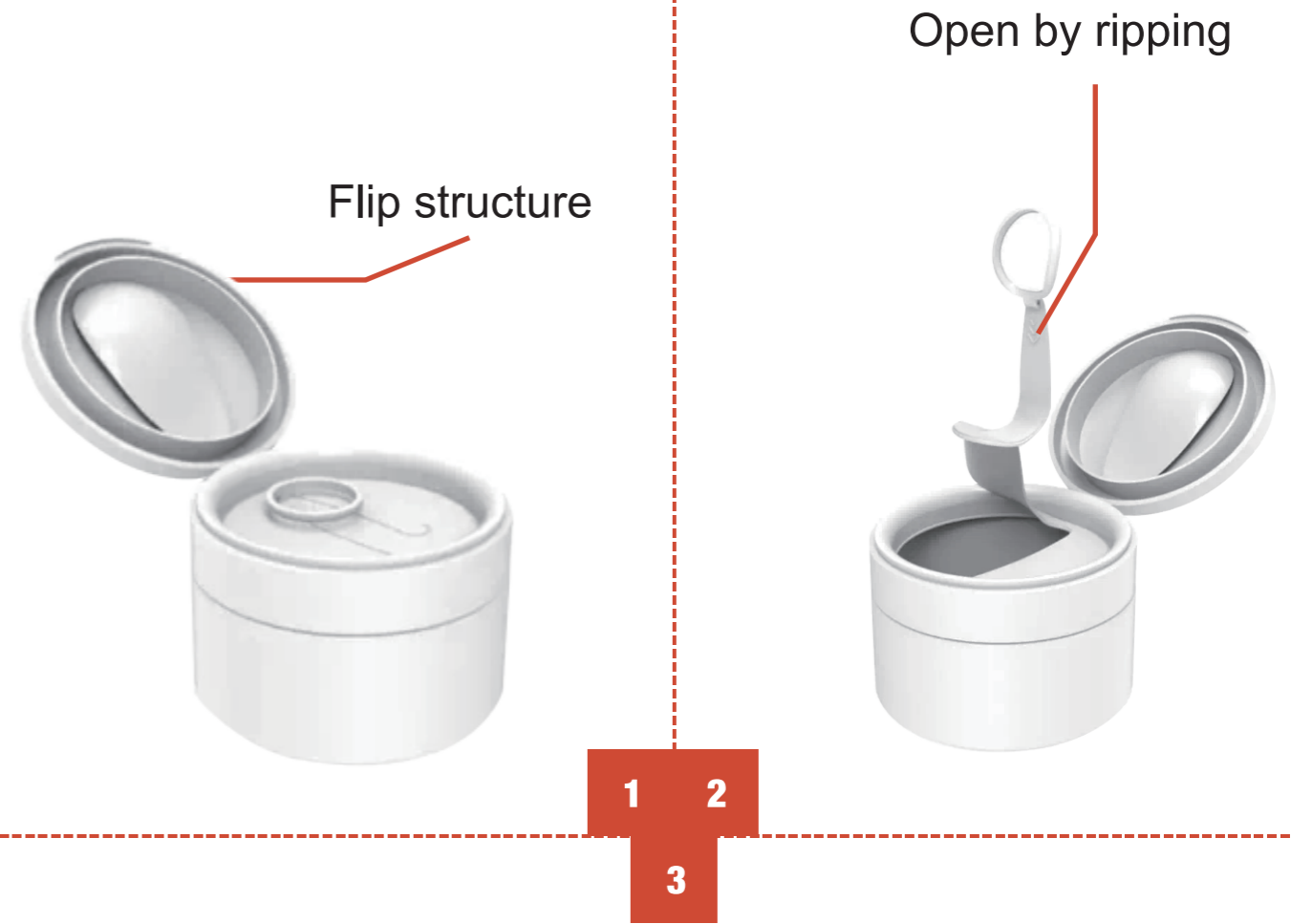

Use a spoon to get
Convenient Hygiene

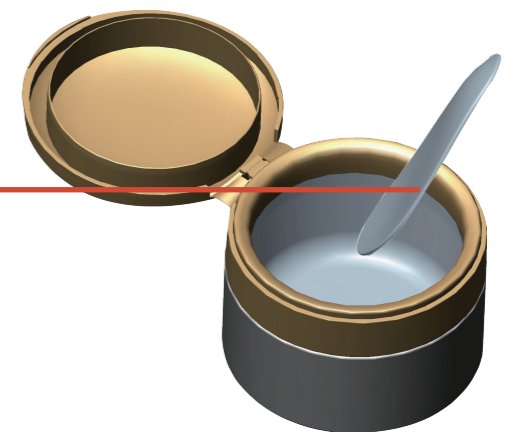

Fresh small bottle

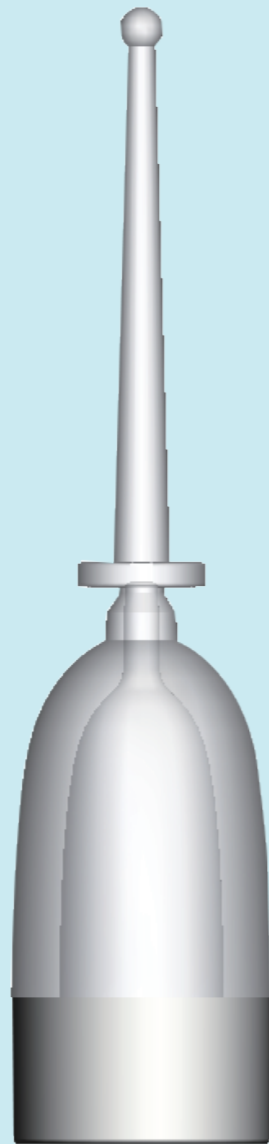

Product Drawing

1

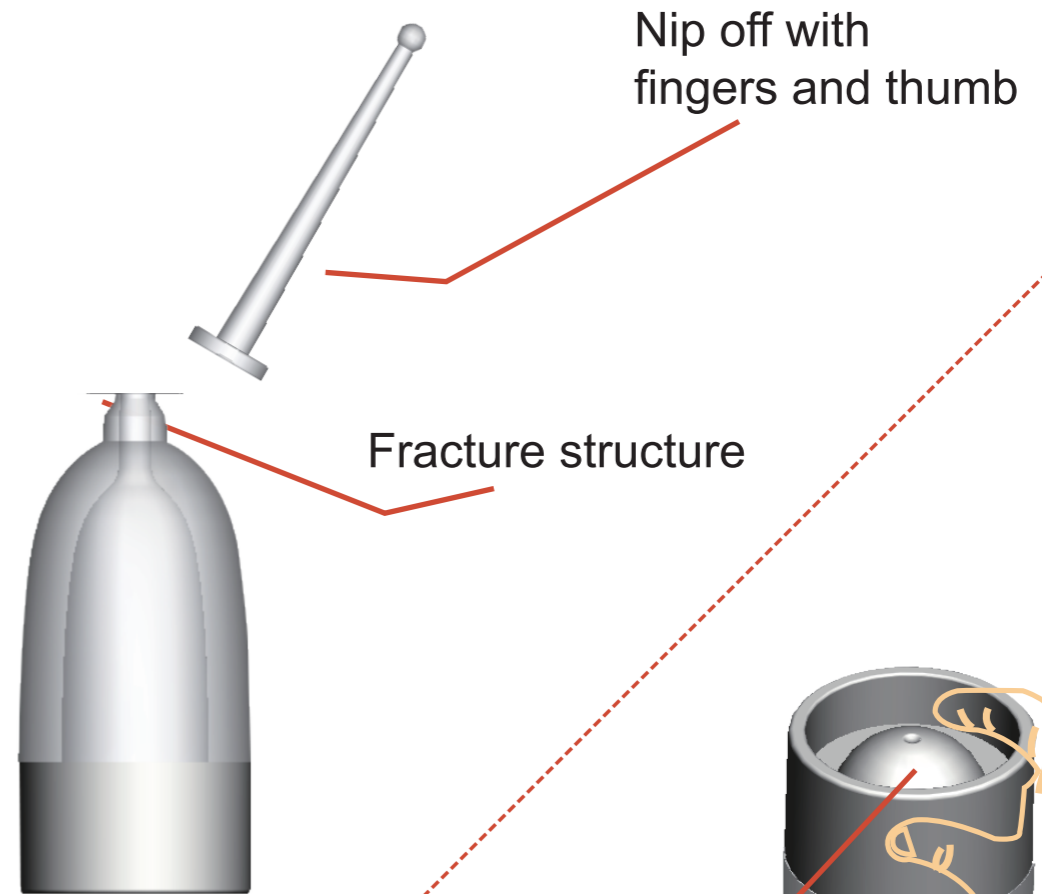

Press use structure
Convenient Hygiene

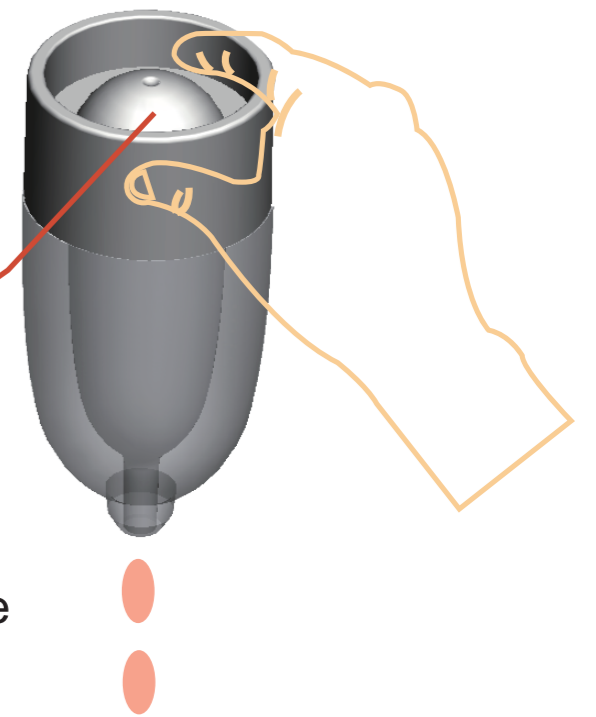

2

Pantent Product



Cream bottle FANXISHOP



Product Drawing

Finished Product



Break the seal

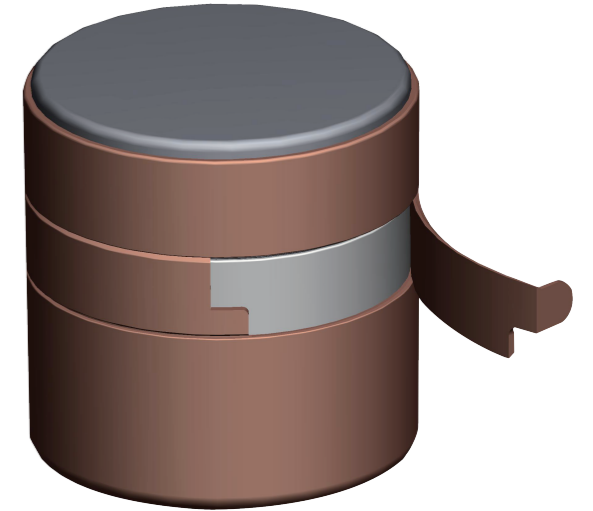

1 2
3 4

Open the lid

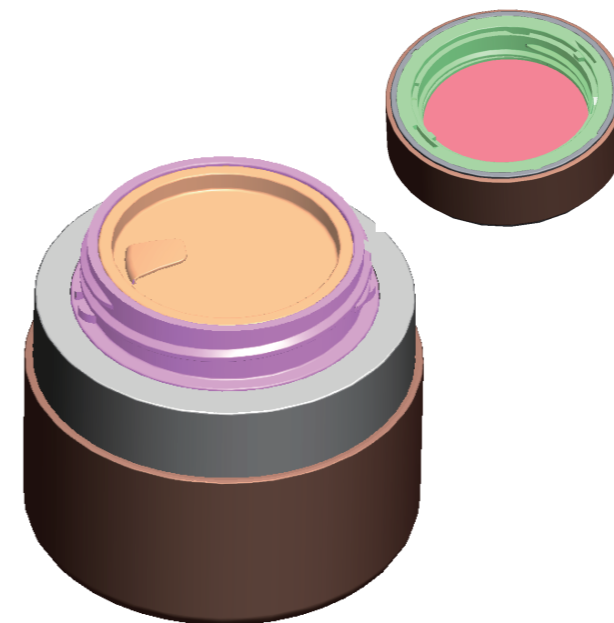

Convenient Hygiene
Backflow prevention

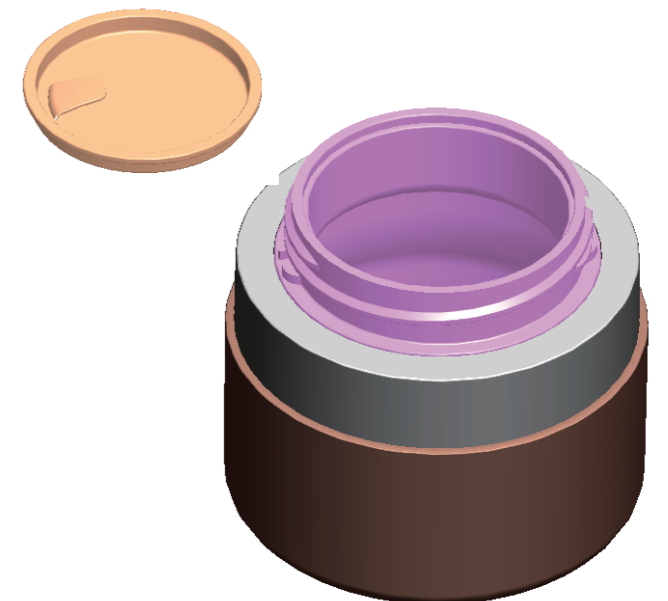

Patent Product



Bath foam bottle HOLA KORA



Product Drawing

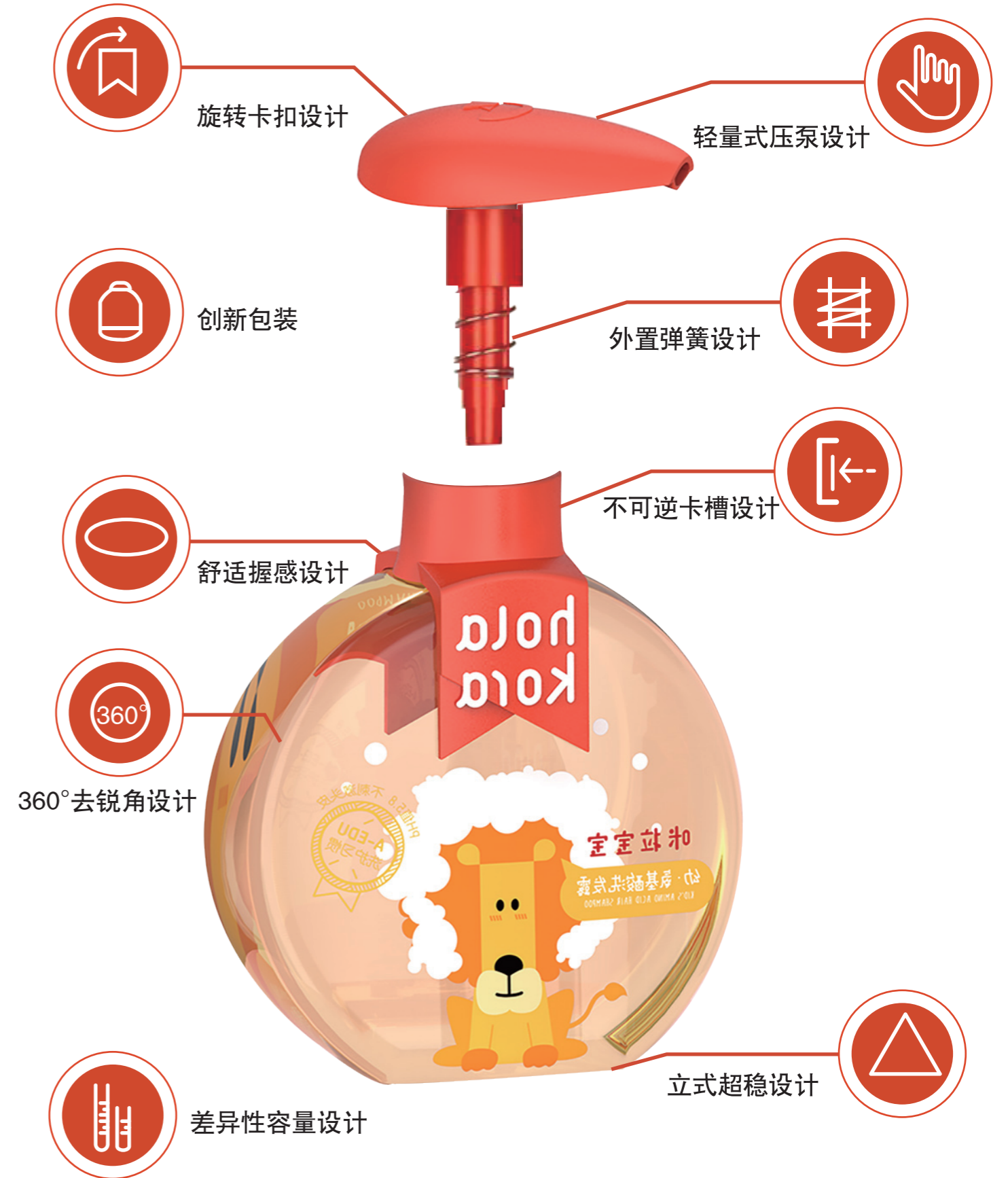

Patent Product



Retain freshness powder bottle



Product Drawing

Press, squeeze, mix

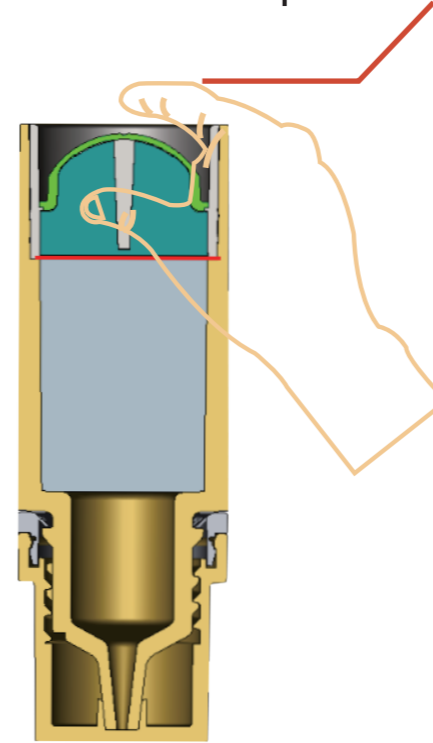

Shaking evenly

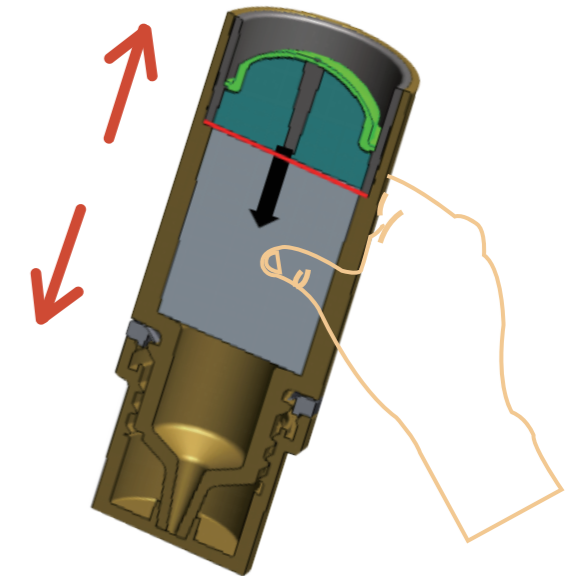

1 2
3 4

Open the safety lock



Press to use

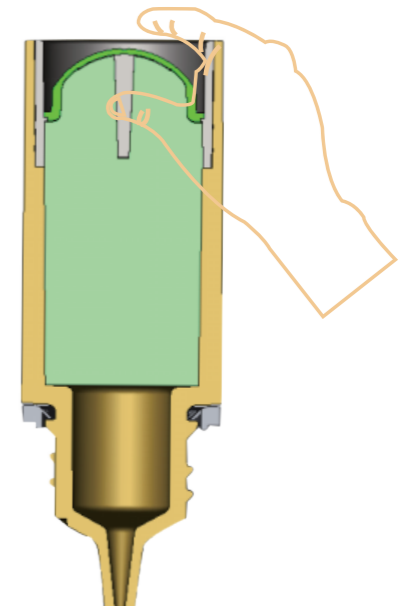

Pantent Product



Cream bottle

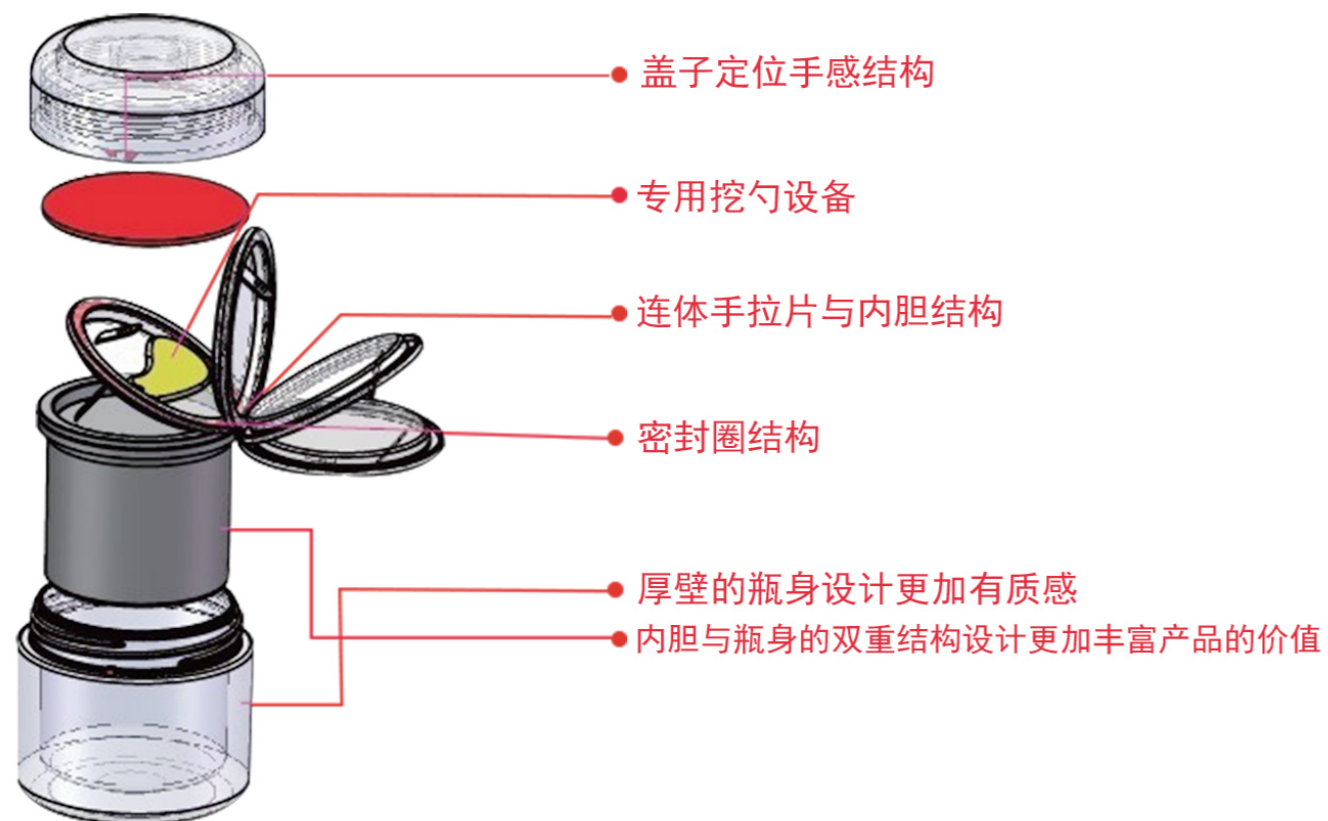

Details

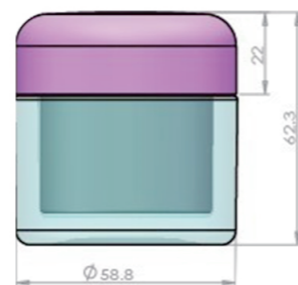

Product Drawing

Finished product



Flip structure

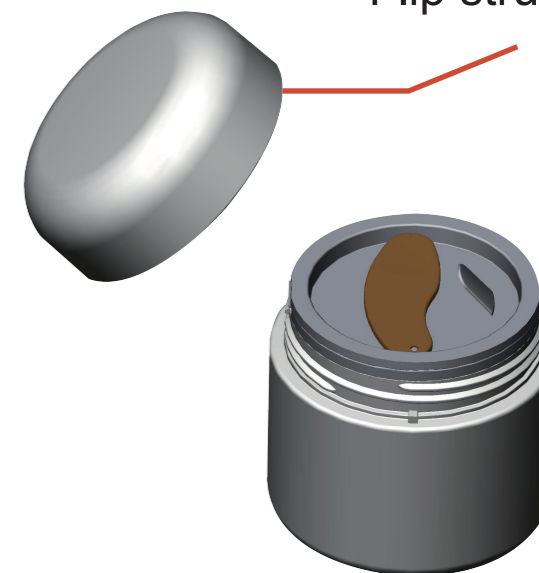

1 2
3 4

Open by ripping

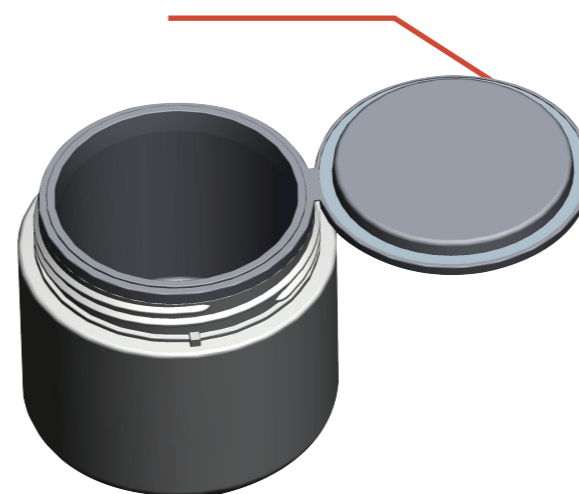

Convenient Hygiene
Use a spoon to get



Cleaning water bottle

AH

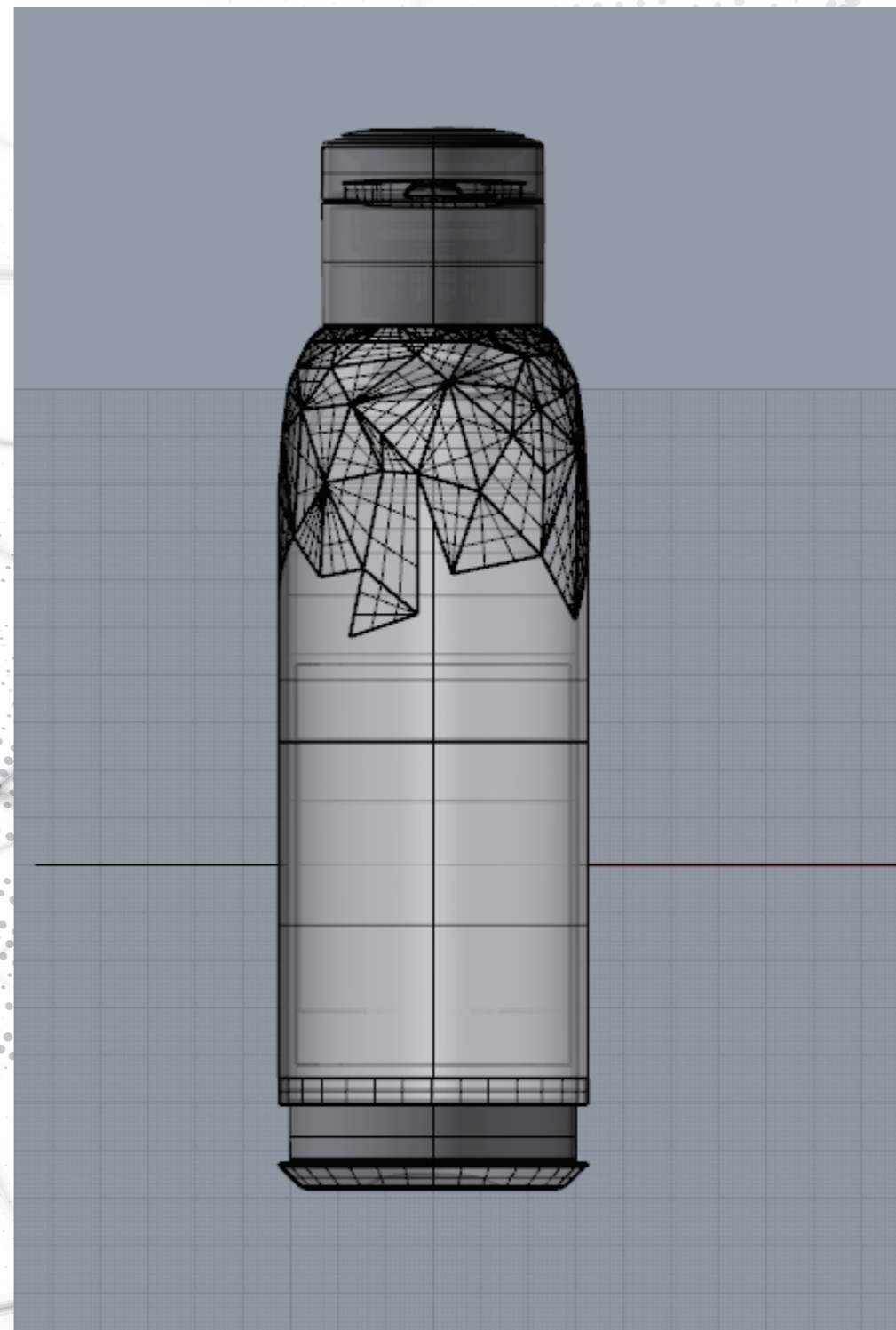

Pantent Product



Liquid flexible hose



Product Drawing



Finished product

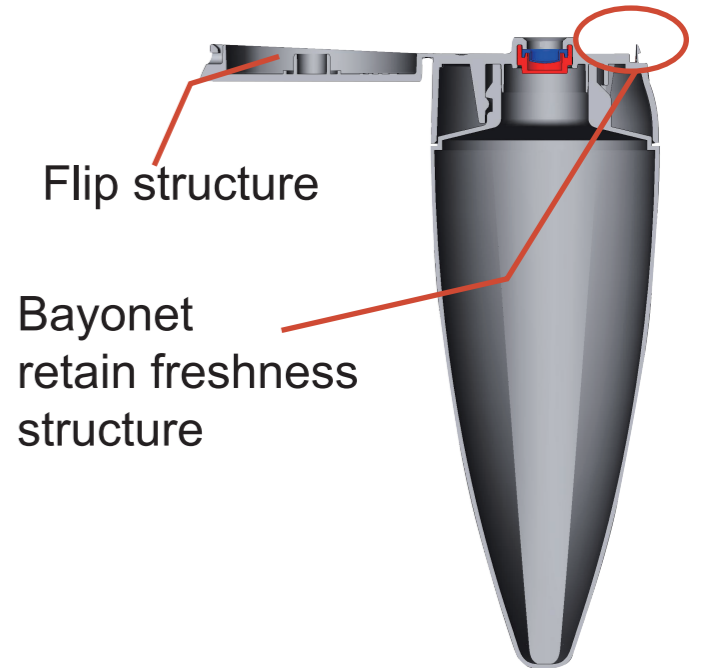

Flip structure

Bayonet retain freshness structure

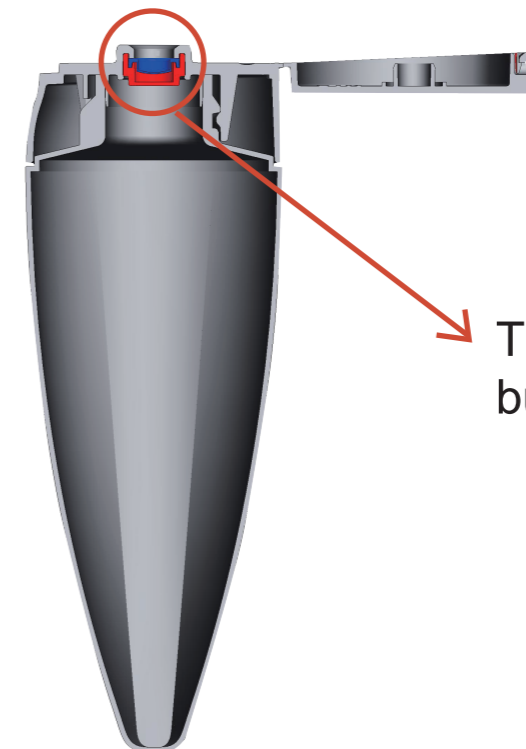

The red part is buffer structure